

(G612) LG-8
Lathe Chuck Guard
Diagram

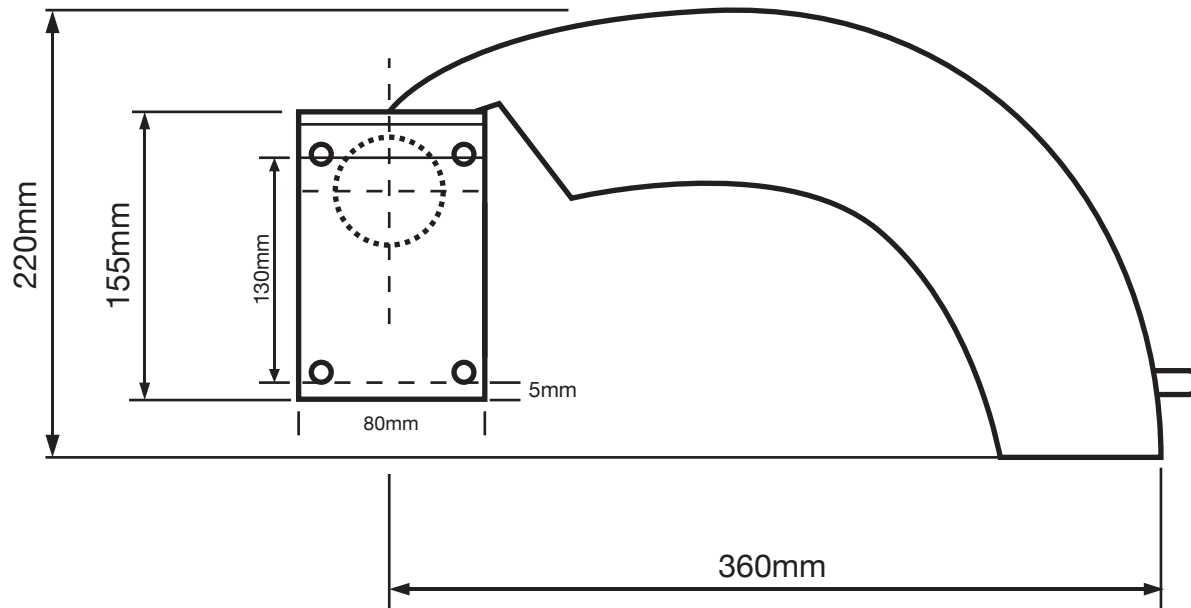
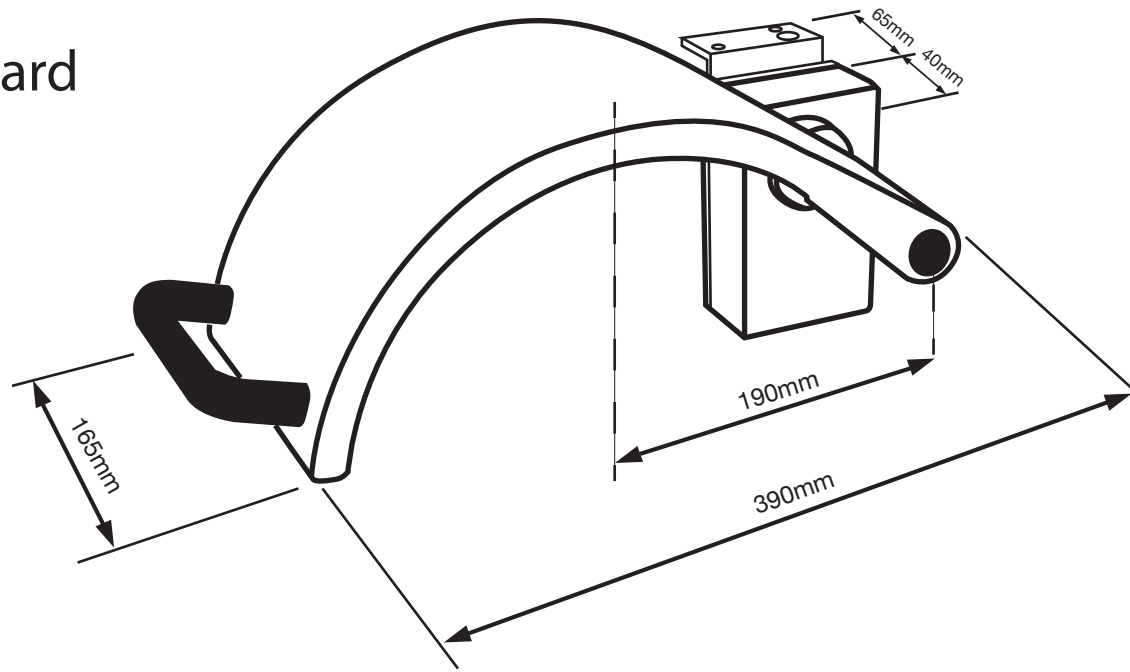

Diagram not to scale